

Otologie
Otology
Otologie
Otología
Otologia

54

Ohr-Spekula
Ear specula
Spéculums auriculaires
Espéculos auriculares
Specoli auricolari

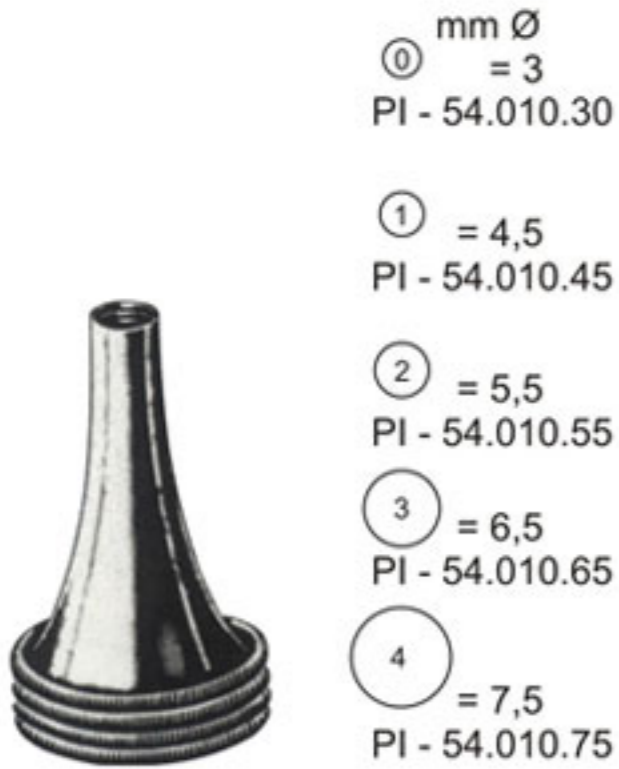

HARTMANN
PI - 54.010.00
Set = 4

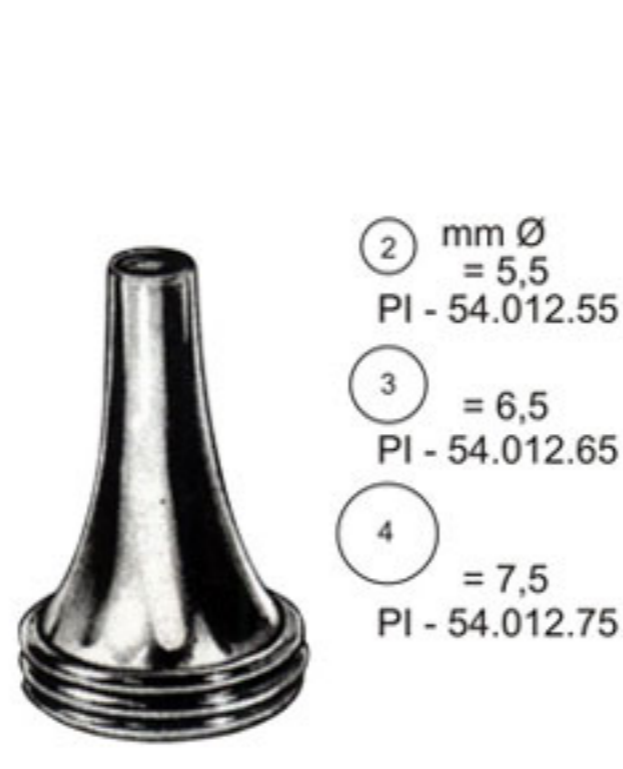

TOYNBEE
PI - 54.012.00
Set = 3

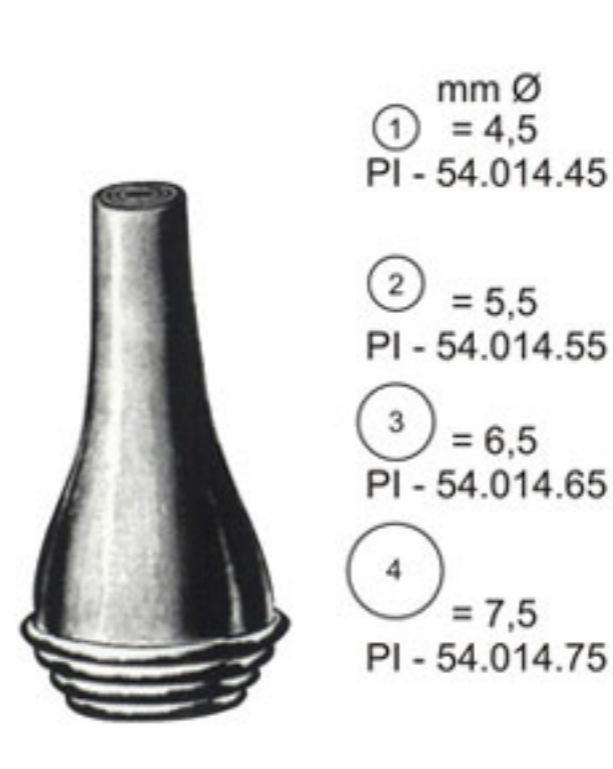

GRUBER
PI - 54.014.00
Set = 4



GRUBER
PI - 54.015.00
Set = 3



BOUCHERON
PI - 54.018.00
Set = 4

- ⑤ PI - 54.018.50
5mm
- ⑥ PI - 54.018.60
6mm
- ⑦ PI - 54.018.70
7mm
- ⑧ PI - 54.018.80
8mm

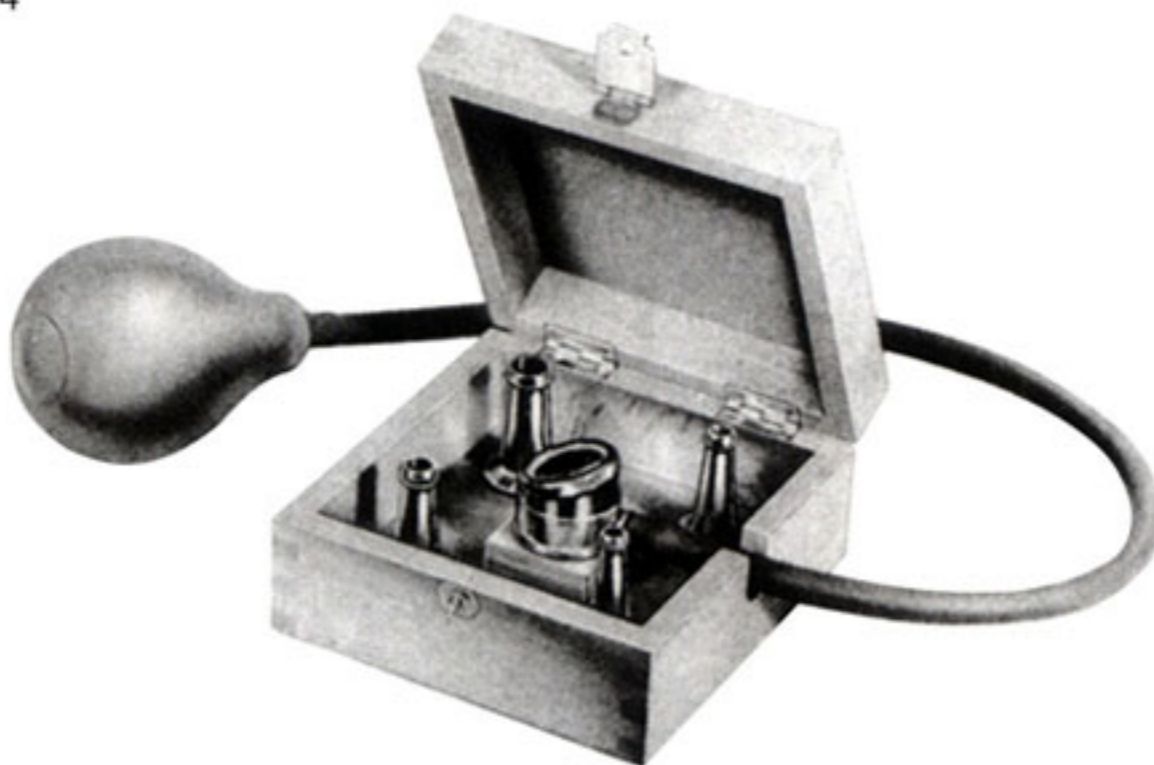

BRUENINGS
PI - 54.030.04
Compl.



SIEGLE
PI - 54.036.03
Compl.

Otologie
 Otology
 Otologie
 Otología
 Otologia

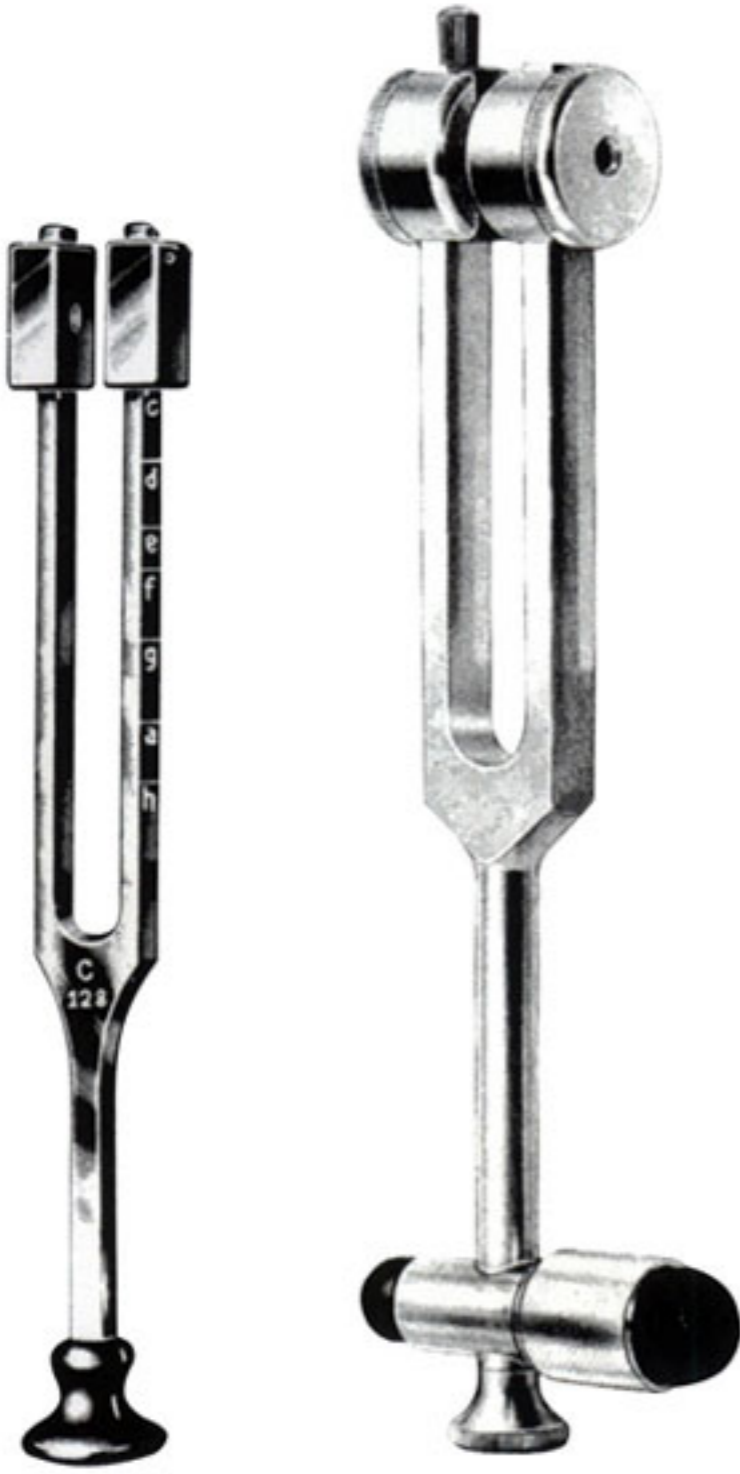

LUCAE
 PI - 54.074.01
 C 128

PI - 54.075.00
 Neurol



RYDEL- SEIFFER
 PI - 54.076.01
 C 64 /c 128

Lärmapparat
 Noise Apparatus
 Assourdisseur
 Ensordecedor
 Assordatore



BARANY
 PI - 54.080.00

Pulverbläser
 Powder Blowers
 Lance-Poudre
 Lanzapolvero
 Insoffiatori per polvere



KABIERSKE
 PI - 54.090.00
 30 cc



KABIERSKE
 PI - 54.090.01
 30 cc

Luftdusche, Ohrspritze
Air Bag, Ear Syringe
Insufflateur d'air Seringue
Insuflador de aire, Jeringa
Insoffiatore d'aria, Siringa

54

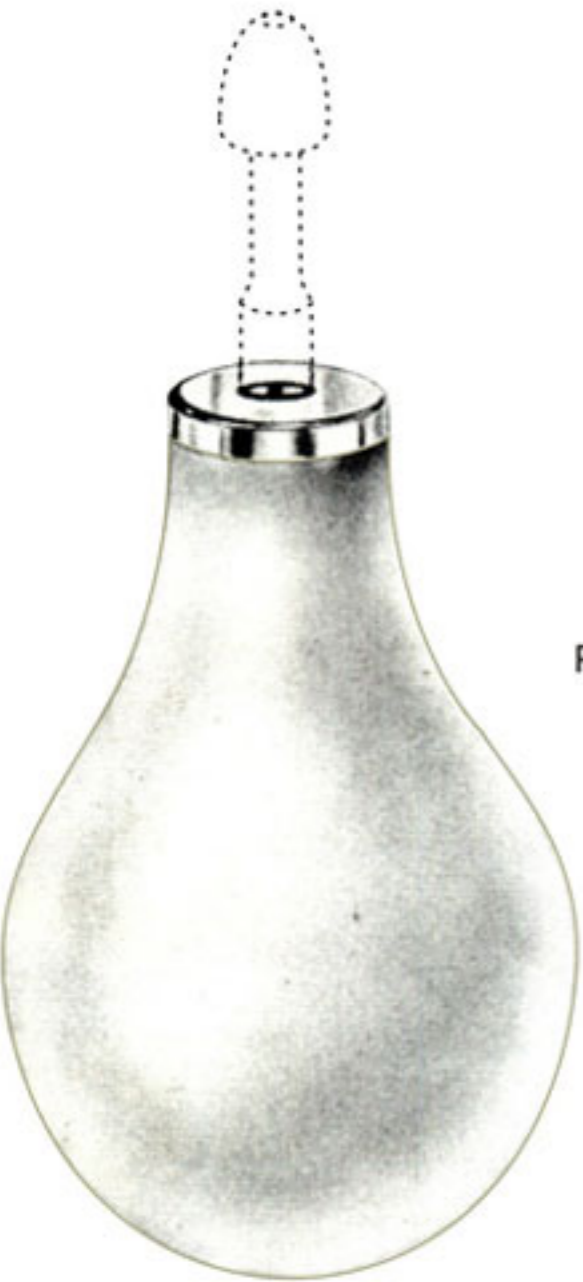

PI - 54.091.03



PI - 54.091.04
4 mm ø



PI - 54.091.15
15 mm ø



PI - 54.091.17
17 mm ø



PI - 54.091.22
22 mm ø

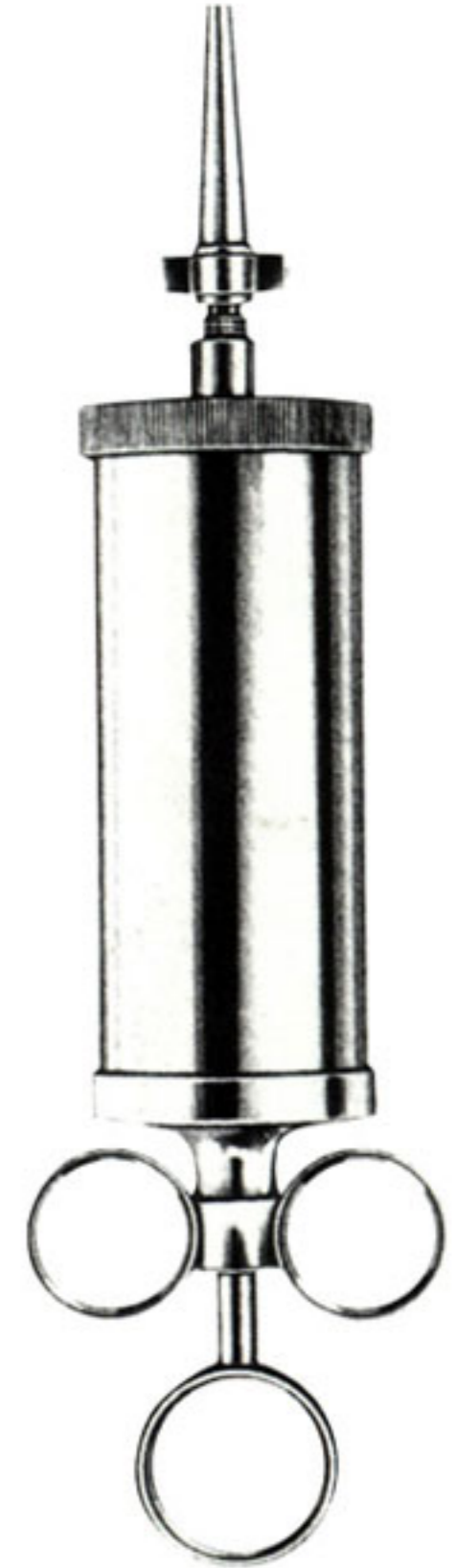

POLITZER

PI - 54.091.00 = incl. PI - 54.091.15, PI - 54.091.17, PI - 54.091.22, PI - 54.091.03
PI - 54.091.01 = incl. PI - 54.091.15, PI - 54.091.17, PI - 54.091.22, PI - 54.091.03, PI - 54.091.04

ml	REINER
50	PI - 54.096.50
75	PI - 54.096.75
100	PI - 54.097.10
150	PI - 54.097.15

Küretten . Currettes .
Curettes . Curetas .
Curette



stumpf . blunt
mousses
romas
smusse



Fig. 00	0	1	2	3	4	5
PI - 54.109.00	PI - 54.110.00	PI - 54.110.01	PI - 54.110.02	PI - 54.110.03	PI - 54.110.04	PI - 54.110.05

scharf. sharp
tranchantes
cortantes
taglianti



PI - 54.111.00	PI - 54.112.00	PI - 54.112.01	PI - 54.112.02	PI - 54.112.03	PI - 54.112.04	PI - 54.112.05
----------------	----------------	----------------	----------------	----------------	----------------	----------------

stumpf. blunt
mousses
romas
smusse



PI - 54.114.00	PI - 54.115.00	PI - 54.115.01	PI - 54.115.02	PI - 54.115.03	PI - 54.115.04	PI - 54.115.05
----------------	----------------	----------------	----------------	----------------	----------------	----------------

scharf. Sharp
tranchantes
cortantes
taglianti



PI - 54.116.00	PI - 54.117.00	PI - 54.117.01	PI - 54.117.02	PI - 54.117.03	PI - 54.117.04	PI - 54.117.05
----------------	----------------	----------------	----------------	----------------	----------------	----------------

Otologie
Otology
Otologie
Otología
Otologia

Katheter, Parazentesenadeln, Ohrmesser, Ohrlöffel
Catheters, Paracentesis Needles, Ear Knives, Ear Spoons
Sondes, Aiguilles à paracentèse, Couteaux auriculaires, Cuillères
Cateteres, Aguja para paracentesis, Cuchillos auriculares, Cucharas
Cateteri, Aghi per paracentesi, Coltelli auricolari, Cucchiari

54

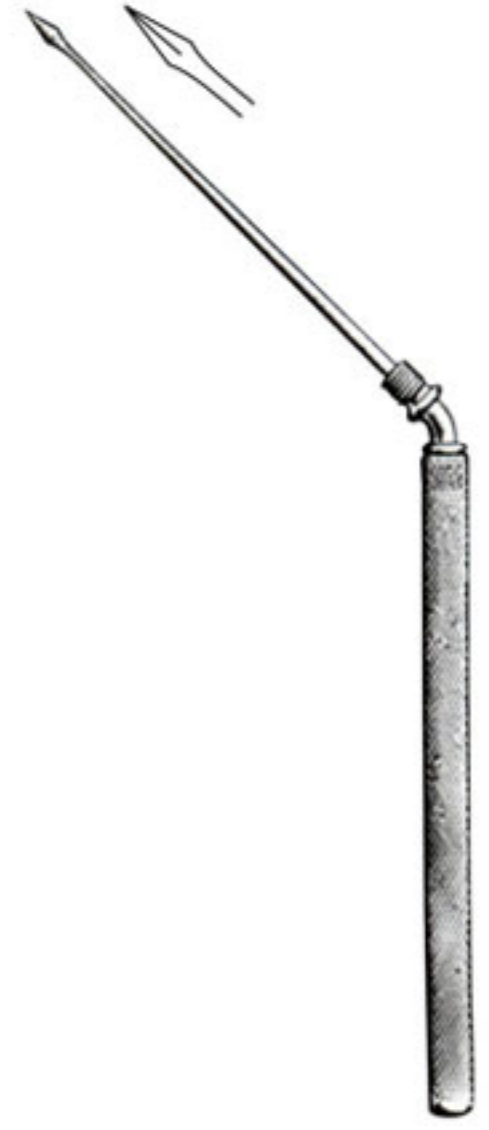
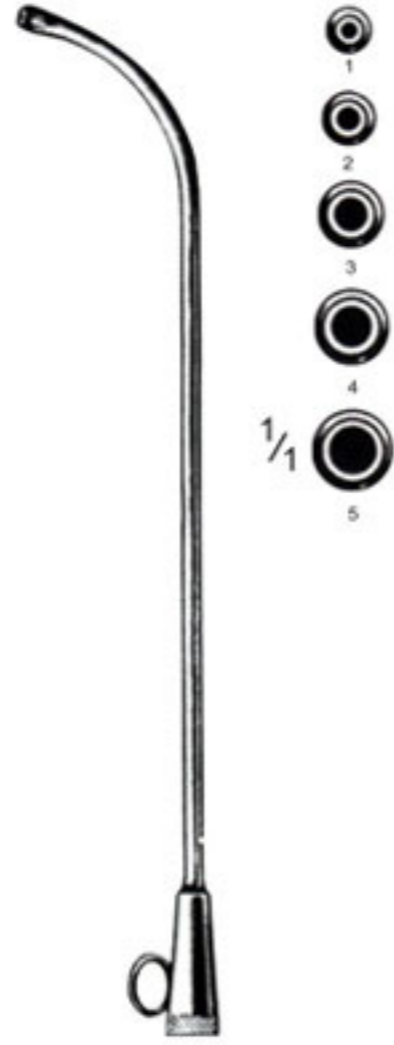
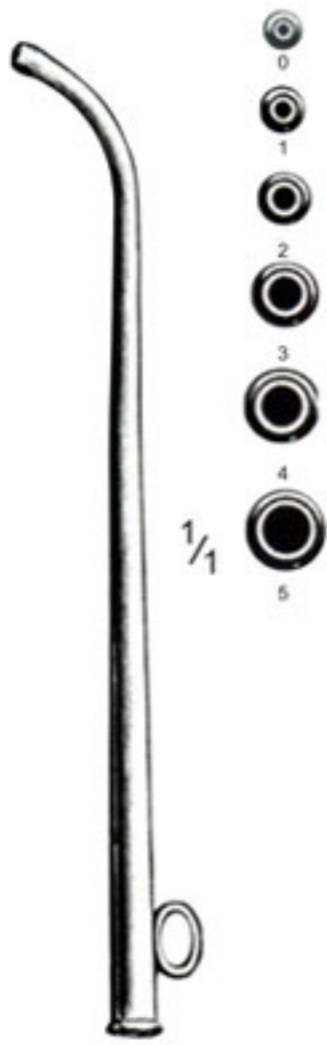

Fig	HARTMANN	ITARD
0	PI - 54.131.00	
1	PI - 54.131.01	PI - 54.133.01
2	PI - 54.131.02	PI - 54.133.02
3	PI - 54.131.03	PI - 54.133.03
4	PI - 54.131.04	PI - 54.133.04
5	PI - 54.131.05	PI - 54.133.05

POLITZER
PI - 54.150.18
18 cm

POLITZER
PI - 54.151.16
16,5 cm

POLITZER
PI - 54.153.16



POLITZER
PI - 54.160.15
15 cm

SEXTON
PI - 54.162.18
18 cm

SEXTON
PI - 54.164.17
17 cm

SEXTON
PI - 54.165.17
17 cm

GROSS
PI - 54.170.12
12 cm

GROSS
PI - 54.171.12
12 cm

Schlingen, Häkchen, Pinzetten, Schnürer
 Loops, Hooklets, Dressing Forceps, Snares
 Anses, Crochets, Pincas, Serrencoeud
 Asas, Ganchitos, Pinzas, Cierranudos
 Anse, Uncinetti, Pinze, Serranodi

Otologie
 Otolology
 Otologie
 Otología
 Otologia

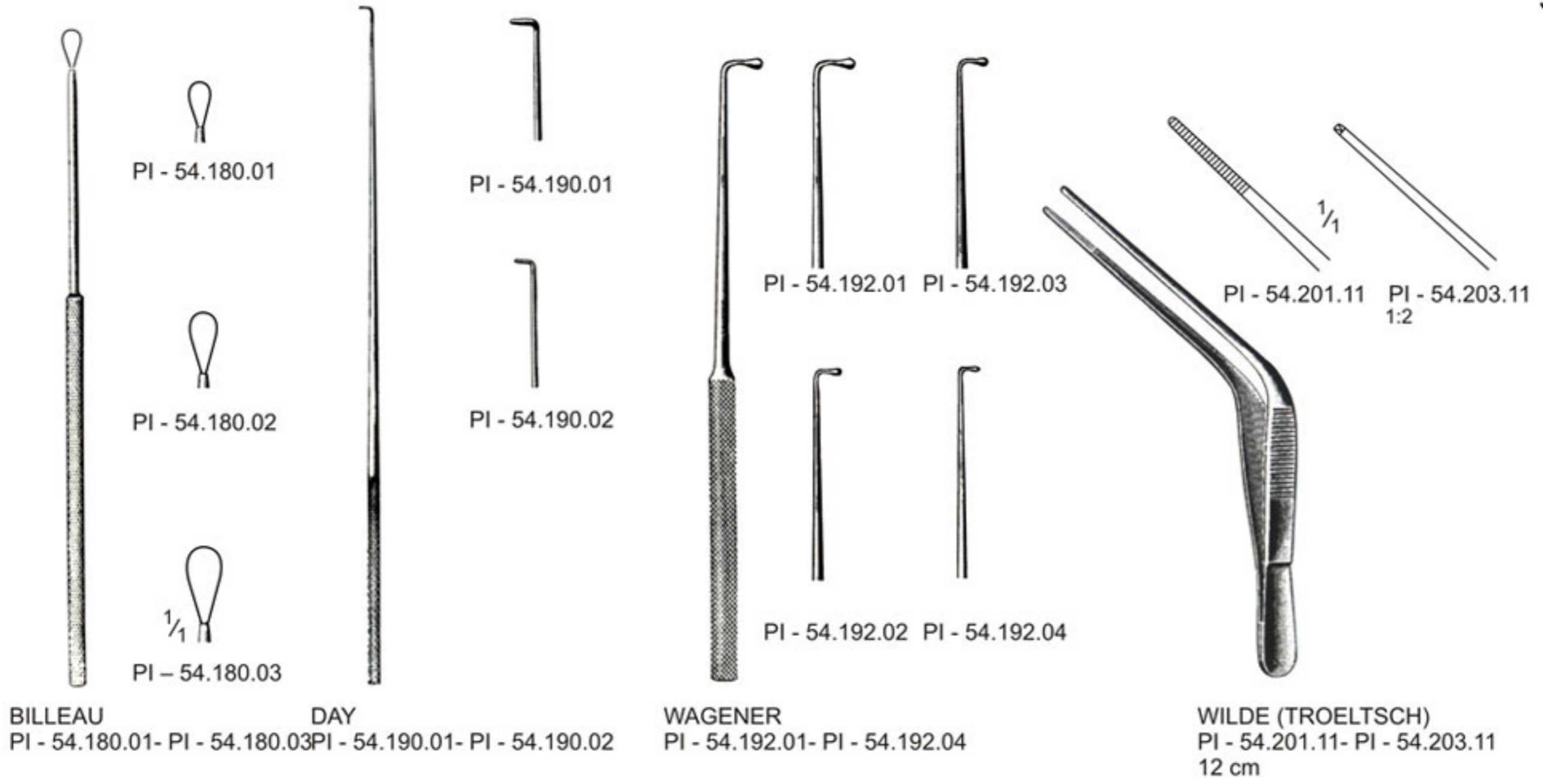

BILLEAU
 PI - 54.180.01- PI - 54.180.03

DAY
 PI - 54.190.01- PI - 54.190.02

WAGENER
 PI - 54.192.01- PI - 54.192.04

WILDE (TROELTSCH)
 PI - 54.201.11- PI - 54.203.11
 12 cm

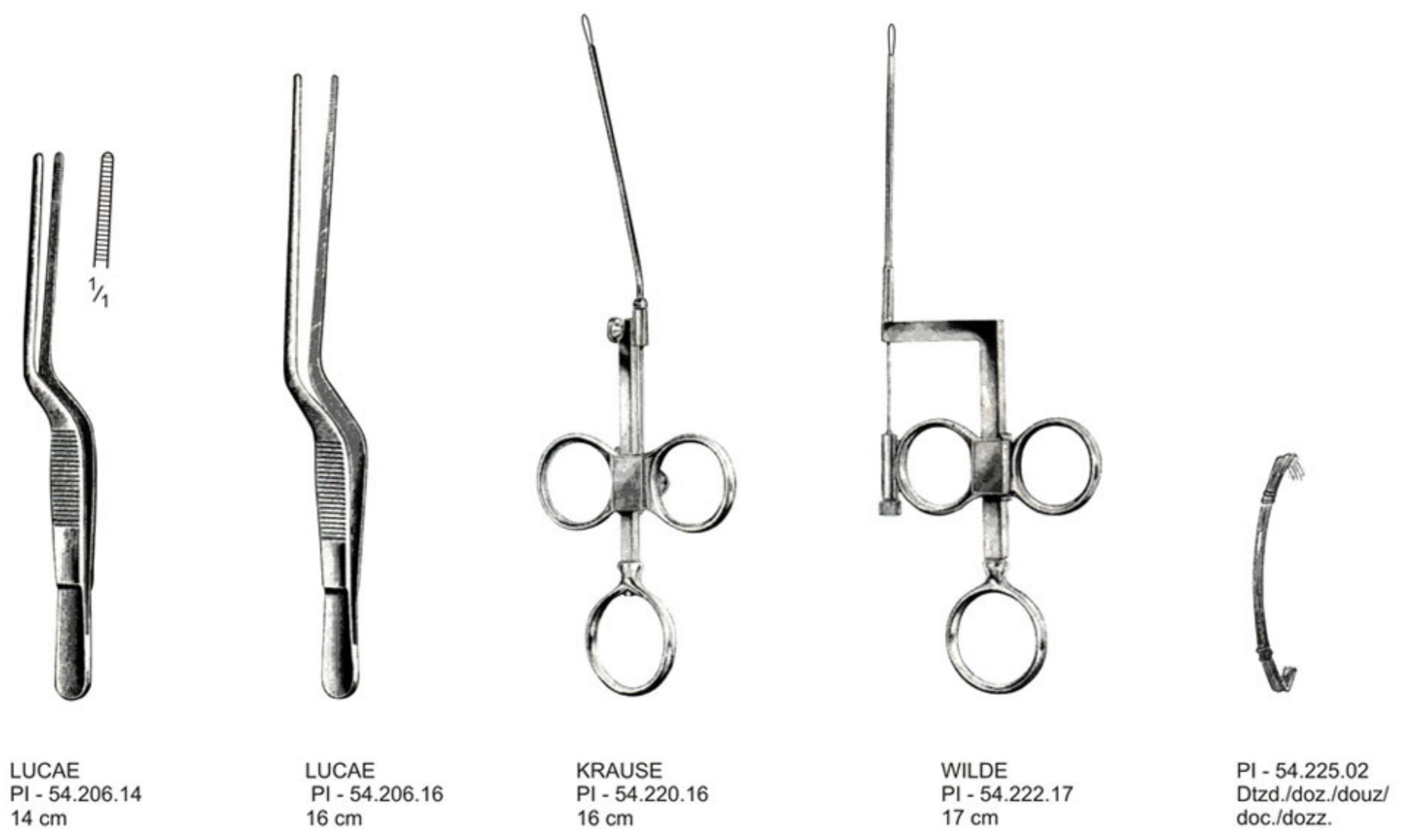

LUCAE
 PI - 54.206.14
 14 cm

LUCAE
 PI - 54.206.16
 16 cm

KRAUSE
 PI - 54.220.16
 16 cm

WILDE
 PI - 54.222.17
 17 cm

PI - 54.225.02
 Dtzd./doz./douz/
 doc./dozz.

Mikro- Ohrscherchen
Micro Ear Scissors
Ciseaux auriculaires micro
Tijeras auriculares micro
Forbici auricolari micro



PI - 54.310.40-PI - 54.322.70



BELLUCCI
PI - 54.310.40
micro mini
4 mm



BELLUCCI
PI - 54.312.55
micro standard
5, 5 mm



BELLUCCI
PI - 54.313.55
micro standard
5, 5 mm



BELLUCCI
PI - 54.315.55
micro standard
5,5 mm



BELLUCCI
PI - 54.317.55
micro standard
5,5 mm



SHEA
PI - 54.320.70
7, 0 mm



SHEA
PI - 54.321.70
7,0 mm



SHEA
PI - 54.322.70
7,0 mm

Mikro-Ohrzängchen
Micro Ear Forceps
Pinces auriculaires micro
Pinzas auriculares micro
Pinze auricolari micro



PI - 54.350.40-PI - 54.360.35



PI - 54.350.40
4 mm



PI - 54.350.70
7 mm



PI - 54.352.40
4 mm



PI - 54.353.60
6mm



PI - 54.355.60
6mm



PI - 54.357.40
4 mm



PI - 54.359.40
4 mm



PI - 54.360.35
3,5 mm

Otologie
 Otology
 Otologie
 Otología
 Otologia

54



SCHUKNECHT
 PI - 54.701.01



SCHUKNECHT
 PI - 54.701.02



SCHUKNECHT
 PI - 54.703.15
 15,5 cm



WULLSTEIN
 PI - 54.704.15
 15,5 cm



TABB
 PI - 54.705.15
 15,5 cm



PLESTER
 PI - 54.706.35
 15,5 cm/ 3,5 mm ø



PI - 54.709.10
 1,0 mm



PI - 54.709.14
 1,4 mm



PI - 54.709.16
 1,6 mm



PI - 54.709.20
 2,0 mm



PI - 54.709.26
 2,6 mm



PI - 54.709.28
 2,8 mm



PI - 54.709.30
 3,0 mm

ROSEN
 PI - 54.709.10-PI - 54.709.30



BARBARA
 PI - 54.710.15



BARBARA
 PI - 54.711.15



BARBARA
 PI - 54.713.15



ROSEN
 PI - 54.715.15



25°
 BARBARA



45°
 BARBARA



90°
 BARBARA



BARBARA

mm	BARBARA	BARBARA	BARBARA	BARBARA
0,3	PI - 54.720.03	PI - 54.722.03	PI - 54.724.03	PI - 54.725.05 = 0,5 mm
0,6	PI - 54.720.06	PI - 54.722.06	PI - 54.724.06	PI - 54.725.10 = 1,0 mm
1,0	PI - 54.720.10	PI - 54.722.10	PI - 54.724.10	
1,2		PI - 54.722.12	PI - 54.724.12	
1,5		PI - 54.722.15	PI - 54.724.15	
2,0		PI - 54.722.20	PI - 54.724.20	
2,5		PI - 54.722.25	PI - 54.724.25	

PI - 54.710.15-PI - 54.725.10

mm	90°	90°	mm McGEE	McGEE	BARBARA		
0,3	PI - 54.730.03	PI - 54.732.03	0,5	PI - 54.733.05	PI - 54.735.05		PI - 54.751.16
0,6	PI - 54.730.06	PI - 54.732.06	1,0	PI - 54.733.10	PI - 54.735.10	15,5 cm	PI - 54.753.16
1,0	PI - 54.730.10	PI - 54.732.10					

mm	ROSEN	25°	25°	45°	45°		
0,3	PI - 54.737.15	PI - 54.741.03	PI - 54.743.03	PI - 54.745.03	PI - 54.747.03		PI - 54.755.16
0,6	15,5 cm	PI - 54.741.06	PI - 54.743.06	PI - 54.745.06	PI - 54.747.06		PI - 54.757.16
1,0		PI - 54.741.10	PI - 54.743.10	PI - 54.745.10	PI - 54.747.10		

FISCH
PI - 54.751.16-PI - 54.757.16

PI - 54.802.16
2 mm

PI - 54.803.16
2 mm

PI - 54.805.16
3mm

mm		
1,0/1,2	PI - 54.760.01	
1,5/1,8	PI - 54.760.02	

mm		
1,0/1,2	PI - 54.762.01	
1,5/1,8	PI - 54.762.02	

3,5 mm
PI - 54.766.35

4mm
PI - 54.766.40

4,5mm
PI - 54.766.45

5mm
PI - 54.766.50

LEMPERT
PI - 54.807.20
20,5 cm

mm	PASSOW	MUCK
2X2	PI - 54.810.02	PI - 54.812.13
3X3	PI - 54.810.03	13 cm

HOUSE
PI - 54.760.01-PI - 54.762.02

HOUSE
PI - 54.766.35-PI - 54.766.50